



Owner's Manual

Inground Swimming Pool Liner

Residential

Safety
Warranty Information
Installation
Maintenance & Chemical Treatment

IMPORTANT

Read over this manual and all accompanying literature before using pool.

INSTALLER'S NOTE

(Read Installation section before removing liner from carton)

Liners fabricated by The Vinyl Works, Inc. are intended for private, residential use. If this is NOT a private, residential pool you should contact your local building department and The Pool & Hot Tub Alliance 2111 Eisenhower Avenue Alexandria, VA 22314-4695 PHTA.org for standards relevant to its use.

NOTICE

The Vinyl Works, Inc. does NOT recommend the use of diving and/or sliding equipment on residential swimming pools. Such equipment, its installation and its use is the responsibility of the pool owner.



Safety Alert Symbol

This is a safety alert symbol. It is used in this manual and on safety signs and labels to alert you to potential hazards. When you see this symbol, read and obey the message that follows it. Failure to obey safety messages could result in serious personal injury or death.

Replacement Owner's Manual and Safety Material

Replacement Owner's Manuals and Safety Materials are available at no charge. To order, call or write to the address listed.

Warranty Service

The liner's warranty statement is included on the back cover of this manual.

Serial Lot Number

Liner serial lot number is indicated on the liner beading and also on the warranty statement.



Dear Pool Owner,

Thank you for purchasing this Vinyl Works Residential Inground Swimming Pool Liner. Your liner was carefully fabricated to provide excellent performance if properly installed and maintained.

Read this manual and all accompanying literature. This is a safety, installation and general maintenance manual. Along with the accompanying notices and safety signage, it is considered a permanent part of this swimming pool liner. It's important to review this manual frequently to familiarize yourself with the liner, your swimming pool and most of all safe use. Follow all safety instructions and make sure all users do the same.

Owner Registration Card -

The liner's warranty statement is included on the back cover of this manual. Read it carefully. Also, complete and return the owner's registration card which is included with this manual.

Customer Service -

If you have any questions or problems concerning this swimming pool liner, contact your local dealer or us directly. We want to ensure your complete satisfaction at all times. When calling or writing the factory please provide serial lot number and liner installation date. The serial lot number is listed on your warranty.

Vinyl Works, Inc
33 Wade Road
Latham, NY 12110
(518) 786-1200

More consumer safety information is available by visiting

www.PHTA.org – or call (703) 838-0083 ext. 301

www.PoolSafety.gov

www.CDC.gov/healthywater/swimming

In Canada visit

Pool and Hot Tub Council of Canada

www.poolcouncil.ca



NOTICE

As defined in the American National Standard for Residential Inground Swimming Pools (ANSI/PHTA/ICC-5 2011) the swimming pool dimensions for which this liner was fabricated is approved for use with manufactured diving equipment. Diving equipment if installed must be done so in strict accordance with these standards. DIVING ENTRY MAY BE ALLOWED ONLY FROM THE POINT AND IN THE DIRECTION ILLUSTRATED IN THESE INSTRUCTIONS.

Copies of
ANSI/PHTA/ICC-5 2011
Standard may be obtained from:



2111 Eisenhower Ave.
Alexandria, VA 22314

Segments of this standard are reprinted,
with the permission of PHTA

The Vinyl Works, Inc. does NOT recommend the use of diving and or sliding equipment on residential swimming pools. Such equipment, its installation, and its use is the responsibility of the pool owner.

Table of Contents

Safety Alert Symbol.....	Front Cover
Warranty Service.....	Front Cover
Serial Number.....	Front Cover
Replacement Owner's Manual and Safety Material	Front Cover
Customer Service.....	Front Cover
SAFE DIVING NOTICE	1
Section I: Safety	2-3
Safety Information Packet	2-3
Safety Equipment	3
Safety Rules	3
Section II: Liner Care and Maintenance	3-4
Water Chemistry.....	3
Water Line	4
Keeping the Pool Full	4
Maintenance Equipment and Automatic Pool Cleaners	4
Leaks	4
Section III: Sanitizing and Chemical Treatment	4-7
Chemical Safety / Water Chemistry.....	4
Pool Capacity	5
Sanitization	4-6
Stabilization	5
Water Balance	6
pH.....	6
Total Alkalinity	6
Calcium Hardness	6
Metals	6
Algae	6
Shock Treatment	6
Water Problem Solver Chart.....	7
Section IV: Pool Maintenance	7-9
Vacuuming.....	7
Winterizing.....	8
Summerizing.....	8
Troubleshooting Chart	9
Section V: Installation.....	10-13
Preparation of the Pool Bottom	10
Preparation of the Pool Structure	10
Installation of the Liner	11-13
Installation of the Face Plates	12
Section VI: Appendix	14-16
Appendix G: Safety Considerations and Warning Recommendations	14
Appendix F: Recommendations to Warn Against Shallow Water Diving.....	15
Appendix H: Safety Brochures and Education Programs.....	15
Appendix K: Entrapment Avoidance.....	16
Warranty	Back Cover
Owner Registration Card.....	Back Cover

Please Note: The Swimming Pool Retailer, Dealer or Installer that you have contracted with for this swimming pool liner is not an agent or employee of The Vinyl Works/ Imperial Pools Manufacturing. We cannot and will not accept responsibility for contracts, representations and statements made by this Swimming Pool Retailer, Dealer or Installer.

SECTION I: Safety

SAFETY FIRST!

Whether your pool is new or just getting a new liner, we want you to receive years of relaxation and enjoyment. But first, before you take the initial dip we want to pass along some important pool safety information. This manual is part of a safety program we provide with each Vinyl Works residential swimming pool liner to give pool owners backyard peace of mind. The program addresses the responsibilities of the pool dealer/installer, the pool owner, and finally, the pool user.

Knowledge of your pool and swimming safety will maximize the enjoyment of all, while failure to follow these safety instructions may result in serious or fatal injury.

Safety Information Package



Safety Sign

It is the dealer or installer's responsibility to install the all-weather pool safety sign in a location near the pool, where it will be seen by all bathers before entering the pool. Insist that anyone who will use the pool is familiar with its configuration, the wading and swimming area, and the safety rules.

No Diving Label

It is the dealer or installer's responsibility to place the "No Diving" labels on your pool. These must be attached to the pool coping, placed to be most visible and most likely to affect the activities of bathers. The decals should be located as shown below, according to the shape of your pool.



Caution Label

Supplied when liner is ordered with a vinyl covered entry/exit. If pool has a non-vinyl covered entry/exit such as a Thermoplastic or Fiberglass Stair and doesn't come equipped with Caution Labels, please contact us and we will send you some at no charge.

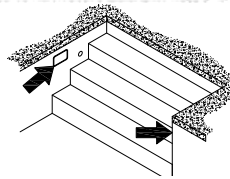

Note: Apply 2 "Caution Stairs may be slippery" decals as illustrated, above water line. (Dealer or installer's responsibility.)

Warning Labels

This safety package includes an orange "Warning" label. This label must be placed on the coping in the location shown by the bold arrow below. (Dealer or installer's responsibility.)



WARNING Make sure that the Safety Sign, "No Diving", and "Warning" labels are placed according to these instructions. Point them out to any bathers before they enter your pool.

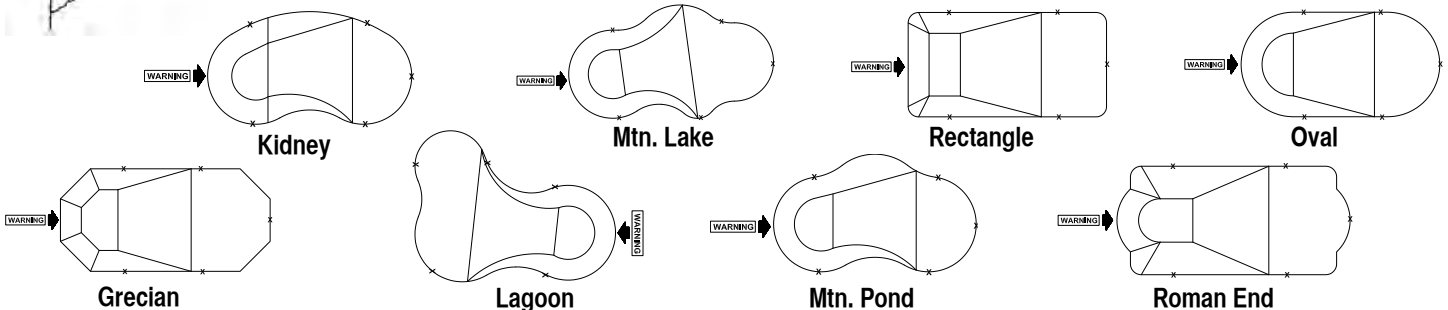
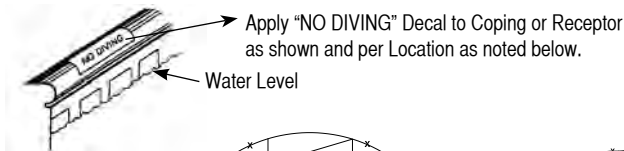

NOTE: x denotes location of No-Diving Labels



WARNING  **IMPROPER DIVING MAY RESULT IN PERSONAL INJURY OR DEATH. Diving Entry is allowed only from the point and in the direction illustrated. Refer to the enclosed literature for safe diving techniques.**



DANGER  **Diving is never allowed from the shallow end or from the sides of your pool.**

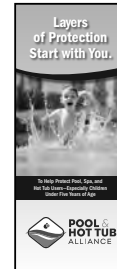
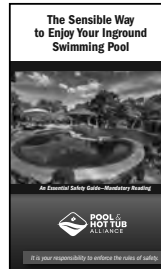

"The Sensible Way to Enjoy Your Inground Pool"

This PHTA publication provides extensive guidelines on pool use and safety. Read it carefully and follow the recommendations.

"Children Aren't Waterproof"

This pamphlet informs you of safety precautions one should adhere to when children are present in and around the pool.

"Layers of Protection"

This PHTA safety pamphlet suggests sixteen safety options to consider for your pool, in addition to adult supervision.

"Pool & Spa Emergency Procedures for Infants and Children"

This brochure focuses on guidelines in preventing drowning accidents and dealing with emergencies related to infants and children.

"Plan Your Dive, Steer Up"

The "Plan Your Dive, Steer Up" pamphlet highlights various proper diving procedures.



WARNING

Before using your pool, the entire family should read and understand all the information contained in these publications. Many serious accidents occur each year in pools. If more people follow the basic precautions outlined in this Safety Package, such accidents could be avoided.

Safety Equipment

Rope and Float Line

The rope and float line should be in place and secured at all times. Generally installed parallel to, and at a minimum of 1 ft. and a maximum of 2 ft on the shallow side of the change in floor slope.

Ladders and Handrails

Ladders and handrails must be in place and secure.

Safety Rules



Alcohol and Drugs

Drinking and/or drug use don't mix with pool related activities. Drinking alcoholic beverages and/or using drugs impairs a person's motor abilities and judgement. An intoxicated or impaired swimmer can cause himself serious injury that can last a lifetime.



Warning

Drinking and/or using drugs must be forbidden in connection with any pool related activity. Anyone who has been drinking and/or using drugs must be prohibited from the pool. You and your family are responsible for your safety and the safety of your guests.

Supervision

Non-swimmers and children should be supervised by a responsible adult.



Warning

Never leave children unattended in a pool area. Accidents can and do happen without a moment's notice.

Horseplay

Running and horseplay around the pool or on the pool equipment should be forbidden.

Water Conditions

Don't allow use of your pool if algae is present or the water is cloudy.

Guests

Always take time to familiarize all your guests with the pool. Show them the handrails, the pool's shallow areas, the rope and float line, the pool's slope, the warning labels, the exit ladder, the pool's deep area and contours, and the pool Safety Sign.

For your safety and that of all your family and guests, be certain that all pool users are aware of all safety information contained in the Safety Package.

Emergencies

Keep emergency safety equipment, a telephone, and a first aid kit in the pool area so that in the case of an accident you won't have to go far for help.

SECTION II: Liner Care and Maintenance

Your Vinyl Works inground swimming pool liner is fabricated from the highest quality virgin vinyl material. This special formulation provides a beautiful and durable pool interior. By exercising common sense and following the instructions provided here, your liner will provide many years of swimming enjoyment. No sharp objects or materials should be allowed in or around your pool.

NOTE: Punctures and tears are not covered under your liner warranty.

Water Chemistry

The maintenance of proper water balance is the single most important factor in maximizing the life and appearance of the liner. See **Section III: Sanitizing and Chemical Treatment** for more information on water chemistry.

PH Levels

Not only do proper pH levels allow the other chemicals to do their work, but it is important to note that low and high levels can cause damage to your liner. Under the right circumstances with pH below 7.0, the liner can actually grow and develop unsightly wrinkles. High pH greatly accelerates the aging process and shortens the life of the liner.

Chlorine

In most areas, the circulating range of 1.0-1.5 ppm of chlorine will do the job of killing the bacteria in your pool water. Above this range high

concentrations will attack the liner, bleach it, and shorten its life, especially if pH levels are too low. Below this range may not kill bacteria, causing unsanitary conditions, possible liner staining and unsafe swimming.

Never let chlorine come in contact with your liner before it is fully dissolved. This means that granular or tablet chlorine is to be dissolved first in a bucket of water, and likewise liquid chlorine, poured in various locations around the pool and immediately agitated, dispersed, and circulated. The broadcasting of tablets, granules, or concentrated chemicals can bleach the liner and shorten the life of the liner.

Slow dissolving sanitizers should not be used in conjunction with automatic timers unless precautions are taken to prevent concentrated chemical solutions from entering the pool.

NOTE: Damage caused by improper addition or use of chemicals is not covered under your liner warranty.

Water Line

Another major contributor to shortening the life of a pool liner is dirt and grime at the water line. The “bathtub ring” is caused by the accumulation of airborne contaminants combining with dirt and body and suntan oils to settle on the liner, and can be baked into the liner by the sun. If the scum line gets baked in, it acts on the vinyl to prematurely dry and crack it, especially in the “sun corner” of your pool.

To reduce this problem, routinely wipe the water line with a sponge (with a mild dish washing solution if necessary) to eliminate grime build-up. If grime build-up has occurred, be sure to use only vinyl cleaners recommended by your pool professional. **Never use abrasive cleaners or pads on your liner. Do not use gasoline, kerosene, or other petroleum products as they WILL cause rapid deterioration of the liner.**

Keep your Pool Filled

Never lower the water level of the pool to less than two feet of water in the shallow area. If water pressure is removed from the liner, it may shrink, causing at least an unsightly liner, and possible tearing around the fittings or in the corners. **Do not drain the pool. Call your pool professional!**

Maintenance Equipment and Automatic Pool Cleaners

Use only vacuum heads, brushes, automatic pool cleaners, and other devices that have been specifically designed for vinyl liner pools.

Never use the telescopic pole in the pool without the attachment.

Abrasion of the print on your pool liner may occur as a result of the use of certain automatic pool cleaners, and this is not covered under your warranty. Not all cleaners cause this abrasion, so consult your pool professional for a recommendation.

Leaks

There is no simple way to find the source of water loss from a swimming pool. The job can be made easier, however, by using a step-by-step approach:

1. Clean the pool completely and make a surface inspection.
2. Find out exactly how much water the pool is losing. Fill the pool to the correct operating level, mark it, and record the drop, morning and evening for a few days. A loss of 1/4 to 1/2 inch per day may indicate evaporation. The cooler air at night will actually cause a higher rate of evaporation than the hot sun. Wind is also a factor, and splash out water should also be considered. A loss of 1/2” to 2 inches per day definitely indicates a problem. More than 2 inches lost should be an easily visible hole in the liner or a broken pipe or fitting.
3. Shut down the filter and plug all inlets and outlets. If the water loss stops, check the plumbing by pressure testing the lines (by a pool professional) or restarting the pump and blocking the individual lines in series and check for water loss in each. Don't forget to inspect the waste line of your filter system for leakage.
4. If the source of your water loss has still not been identified, shut down the filter, plug all inlets and outlets, and let the water level drop until it stops, but only to the bottom of the lowest cutout in the liner (return fitting, deep suction, underwater light). Inspect the water line for holes at this level.
5. At this point, the problem has been narrowed down to a small hole in the liner, and an underwater inspection, with a diving mask, is required. Before proceeding the pool should be absolutely spotless. Check the corners and the entire area where the bottom meets the side wall first. Using a dye such as the phenol red found in swimming pool test kits will help determine if a suspected area is in fact leaking.
6. If a hole is found, repair it using one of the many quality vinyl liner patch kits currently on the market. Most patch adhesives work very well under the water, eliminating the need for draining the pool. Follow the fabricator's instructions.

SECTION III: Sanitizing and Chemical Treatment

Water Chemistry

Proper Water Chemistry is critical to the quality, clarity and most importantly, purity of your swimming pool water. This includes application of the sanitizers and auxiliary chemicals in the proper dosages as required. The maintenance of proper water balance also is the single most important factor to maximizing the life and appearance of the liner. Proper technique is important for water testing. See your Pool Professional for test kits and testing procedures. Be sure to read and follow the written instructions from the chemical manufacturer.

It is equally important to maintain proper water balance when your pool is equipped with a Salt Chlorine Generator, Ozonator, Mineral Reservoir, or any other alternate water sanitizing treatment system. Always follow the manufacturer's instructions, improper use that may cause damage to your swimming pool liner is not covered under the limited warranty.

Notice: Pools that are covered in season should be uncovered once daily to release excessive chlorine/chemical vapor. This will help avoid high concentrations of airborne chemicals building up between the water and the cover. Excessive chlorine/chemical vapor can cause premature liner failure and is not covered under the limited warranty.



Warning

Read and follow all chemical label directions. Failure to follow package directions may result in fire and/or explosion.



Warning

To avoid fire and/or explosion, NEVER mix a pool sanitizer or chemicals with any other pool sanitizer or chemicals. NEVER add water to pool chemicals. Always add pool chemicals to water.



Warning

Keep all chemicals sealed and out of reach of children.

Pool Capacity

Swimming pool chemical recommended dosages are listed by the number of gallons of water your pool contains. Review the formulas listed here to help you estimate your pool's capacity.

How To Measure Your Pool's Capacity

RECTANGULAR	CIRCULAR	OVAL
Length X Width X Average Depth X 7.5 = Total Gallons	Diameter X Diameter X Average Depth X 5.9 = Total Gallons	Long Diameter X Short Diameter X Average Depth X 5.9 = Total Gallons
X	X	X
X	X	X
X	X	X
7.5 =	5.9 =	5.9 =
Total Gallons	Total Gallons	Total Gallons

Average Pool Depth = Depth of Deep End + Depth of Shallow End = Total Feet ÷ 2.

Sanitization

Proper filtration will remove most suspended debris from your pool, however, filtration alone is not enough. Chlorination is required to disinfect pool water. The proper combination of filtration and chlorination is necessary to keep pool water sparkling clear.

Chlorine must be added to accomplish the following:

1. Kill any bacteria and/or algae present in the water.
2. Supply a residual or active supply of chlorine to kill new bacteria and to prevent the growth of algae. A chlorine residual of 1.0-3.0 ppm (parts per million) must be in water at all times.



Warning

Read and follow all chemical label directions. Failure to follow package directions may result in fire and/or explosion.

Stabilizing the Water

Stabilizing your pool water before beginning routine sanitizing gives you two highly desirable advantages—convenience and economy.

Stabilizing your pool means adding cyanuric acid, sometimes called a “conditioner,” to the water before adding your regular pool chlorinator. This is done to increase the chlorinator's effective sanitizing life, since sunlight causes the chlorine in the pool to dissipate quite readily. Cyanuric acid protects the chlorine from the debilitating rays of the sun. This means you don't add chlorine as often; what you save is time and money.

Your need to add stabilizer depends on the current cyanuric acid level in your pool.

Use a test kit to get a reading or take a sample to your pool dealer. Your cyanuric acid should be in the 20-25 ppm range.

Pool Sizes and Water Capacities

(Approximate Gallonage)

Rectangle	Oval	Roman End
12' X 24' - 7,850	16' X 32' - 15,850	16' X 37' - 17,850
14' X 28' - 10,450	18' X 36' - 19,250	18' X 41' - 22,150
16' X 32' - 17,550	20' X 40' - 25,200	20' X 43' - 26,100
16' X 36' - 18,800		
18' X 36' - 21,500		
20' X 40' - 28,000		
Kidney	Mountain Pond	Mountain Lake
15' X 26' - 8,650	18' X 30' - 11,250	20' X 32' - 11,050
16' X 30' - 11,900	20' X 34' - 17,700	21' X 32' - 13,400
16' X 33' - 16,900	22' X 36' - 20,100	21' X 40' - 17,950
18' X 36' - 18,650	24' X 40' - 24,800	23' X 37' - 20,000
20' X 38' - 20,600		23' X 42' - 22,300
		26' X 40' - 23,250
		24' X 44' - 24,200

Water Balance

Balanced water is a term used to describe an ideal condition of pool water. Water is "Balanced" if it contains just the right amount of pH, Total Alkalinity, Calcium Hardness, and Metals. Unbalanced water can have scale forming or corrosive tendencies.



Warning

Read and follow all chemical label directions. Failure to follow package directions may result in fire and/or explosion.

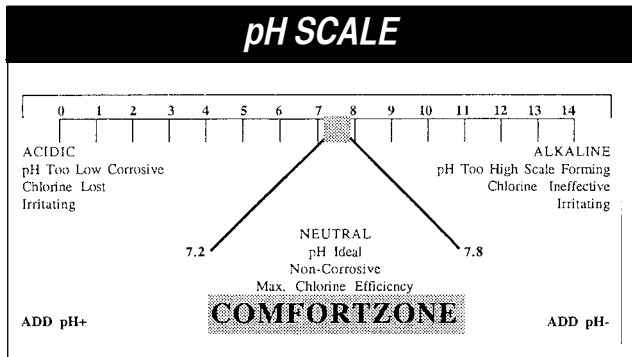

PH

pH is the measure of the degree of pH acidity or alkalinity of pool water. Practically speaking, it tells if water is neutral or how far away from neutral.

pH is a measure on a scale, to which numbers have been assigned, from 1 to 14, 7 is the middle of the scale and is considered exactly neutral. Readings below 7 are increasingly *acidic*, above 7 are increasingly basic or *alkaline*. Under normal conditions, it has been found that the proper pH for pool water is approximately 7.5 with pH 7.2-7.7 being an acceptable range. The chart above indicates different tendencies at assigned pH readings and what chemical to add.

Total Alkalinity

Alkalinity represents the amount of alkaline minerals in water. It is the measure of the buffering capacity or resistance to a change in pH of water. It minimizes changes in pH, making pH easier to control.

Alkalinity and pH are sometimes confused. pH is a measure of DEGREE of acidity of water. Alkalinity is a QUANTITATIVE measure, telling you the total amount or quality of alkaline minerals present.

The proper alkalinity range is 80-120 ppm. If alkalinity is allowed to drift, corrosion or scaling may result. Have your pool water tested periodically for alkalinity by a qualified dealer.

Calcium Hardness

Total Hardness is used to describe the total amount of dissolved calcium and magnesium bicarbonates, as well as smaller quantities of other minerals, in water.

Unbalanced water, high in hardness, can become cloudy. Scale can form inside pipes, restricting water flow. It can cause calcification of sand in filters, reducing their efficiency. Scale can also discolor a pool's interior.

On the other hand, low hardness and unbalanced water can contribute to corrosive water conditions.

Therefore a certain amount of hardness is desirable. The desired range is between 100-200 ppm. Once again, your water should be tested periodically for hardness by a qualified dealer.

Metals in Your Water

Stain-causing metals, such as iron, copper and manganese, can enter the pool water from the erosion of metal components in the recirculation system, from the improper use of copper based algaecide or simply from their natural occurrence in the source of water. Simply adding a chemical (such as chlorine) can cause the metal to drop out of solution and onto the surface of the pool, causing a stain. In some cases, even prolonged sunlight can cause this to happen.

Most home test kits do not have tests to detect metals, but your local swimming pool professional does. The best way to treat metals is by preventing them from turning into stains. This is what a stain and scale control product is designed to do—tie up the metals. If a stain does occur, treating it may remove it. The fresher the stain, the better the chance for removal.

Algae

Algae can sneak up on you without notice. Algae spores are always in the atmosphere and soil. Rain showers, winds and dust storms are constantly dumping these spores into your pool. Sunlight and warm temperatures provide the climate for algae to reproduce and grow. You can have millions of algae cells in a single ounce of pool water before you can even see them.

When you finally do see algae, it can be costly. Green floating algae can clog your filter within a short time. This slows down water circulation and the chemicals that protect your pool. Black algae is very resistant and clings to walls, floors and surfaces. Mustard algae, named for its yellow-green color, is very resistant to chlorine. It brushes off easily but quickly returns. Algae can ruin the appearance of your pool and make it unsafe with slimy, slippery walls and floors. The best way to take care of algae is never let it appear. An algae preventative added to your pool water can prevent algae growth.

Shock treatments

As foreign matter enters your pool, your chlorine demand will increase, resulting in decreased chlorine residual. Foreign matter may enter your pool by swimmers, wind, and rain. It may consist of organic wastes such as perspiration, urine, saliva, sunscreens and pollutants.

Periodic shock treatments are required to maintain the proper level of chlorine residual. This can be accomplished by using a heavy dose of chlorine (3-5 times your normal daily dosage.) Shock treatments should be done once a week during peak season when temperatures and bather load are heavy. Cloudiness and/or strong chlorine odors are indications that a shock treatment is needed.



Warning

Read and follow all chemical label directions. Failure to follow package directions may result in fire and/or explosion.

CHEMICAL PROBLEM SOLVER CHART

PROBLEM	SYMPTOM	CAUSE	REMEDY
GREEN WATER	Green color	Algae Corrosion of copper	Adjust pH, shock treat with Shock Treatment. Repeat if necessary. Follow the program outlined in the Dosage Chart. Follow remedies for colored water and corrosion of metal parts.
CORROSION OF METAL PARTS	Metal fixtures in contact with pool water being eaten away; rust stains; copper stains; colored water.	Low pH and/or Low alkalinity and/or Low calcium hardness	Adjust pH to 7.2-7.6 by adding pH Plus. Raise alkalinity to 60-100 ppm if using Chlorine Granular and 90-125 ppm if using Chlorine Tablets or Sticks. Raise calcium hardness to minimum of 200 ppm by adding Calcium Plus. Follow label instructions.
CHLORINE ODOR	Swimmers' eyes become irritated, water has an unpleasant odor, complaints of "too much chlorine" in the water.	Chloramines formed by reaction with bather waste	Adjust pH to 7.2-7.4, shock treat with Shock Treatment. Repeat if necessary.
EYE AND SKIN IRRITATION	Red eyes, itching skin.	Chloramines (see chlorine odor) Improper pH	Adjust pH, shock treat with Shock Treatment. Readjust pH with pH Plus (soda ash) or pH Minus (dry acid) or muriatic acid to 7.2-7.6 range.
ALGAE	Green or brown algae turn water green, pool surfaces feel slippery. Can also cause cloudy water. Black algae forms patches on pool sides, giving them a spotty look.	Insufficient chlorine High stabilizer level Improper pH	Adjust pH, shock treat with Shock Treatment. Vinyl Liner: Use soft nylon brush. Repeat if necessary. Add Algaecide. Follow dosage recommendations on label.
SCALE FORMATION	Scale on pool walls and fixtures. Frequent in new inground pools.	High pH Excess alkalinity Excess calcium hardness (over 1,000 ppm)	Reduce pH to 7.2-7.6 with pH Minus or muriatic acid. Use pH Minus or muriatic acid to reduce total alkalinity to 60-100 ppm if using Chlorine Granular, 90-125 ppm if using Chlorine Tablets or Sticks depending on pH and calcium hardness. Lower calcium hardness if necessary by draining water and replacing with water having lower hardness.
COLORED WATER	Brown Black Blue-Green	Iron Manganese Copper	Shock with Shock Treatment. Floc pool or sand filter with alum (not recommended for D.E. or cartridge filters). Follow remedy for corrosion of metal parts. To prevent colored water, use Stain and Scale Controller. Follow label instructions.
EXCESSIVE AVAILABLE CHLORINE	Bleached hair and bathing suits. Possible eye irritation.	Excess chlorine	Add sodium sulfite or sodium bisulfite or sodium thiosulfate.
CLOUDY WATER	Hazy, cloudy water, lack of sparkle.	Early algae growth Pool filtration High pH; high alkalinity	Adjust pH to 7.2-7.4, shock treat with Shock Treatment. Check filter operation. Readjust pH with pH Minus or muriatic acid to 7.2-7.6. Add Clarifier to aid filter in removal of fine suspended particles. Follow label instructions.

SECTION IV: Pool Maintenance

These are general instructions for the maintenance of your swimming pool. Differing construction techniques and equipment make it impossible to cover all the aspects of pool operation in this publication. Refer to the manufacturers' instructions provided with the equipment used on your pool.

Vacuuming

Swimming Pool walls and floor should be cleaned when necessary with a pool vacuum cleaner to remove loose dirt, dust and soil that may have settled or collected on the pool sides and bottom. Soil particles and debris enter the pool from bathers, wind, rain, trees, and precipitation of algae. They sometimes settle to the bottom and pool sides before the filter can remove them from the water. If allowed to remain, staining can occur. Also, a dirty pool can be unsafe, unsightly and uninviting.

Vacuuming Instructions:

1. Assemble the components of your vacuum set: vac hose, vac head, pole, and skim-vac.

Note: Use only vacuum heads, brushes, and other maintenance equipment that has been specifically designed for vinyl liner pools. Also, if your pool is equipped with a bottom drain, turn it off before you start vacuuming. This will give you the maximum suction to vacuum with.

2. Fasten vac head to pole
3. Slip vacuum hose onto vacuum head
4. Extend the pole and place vacuum head and hose into the pool, resting the pole in a corner to prevent it from slipping into the pool.
5. Fill the vac hose with water by holding the unattached end over a return inlet until air bubbles stop coming from the vac head.

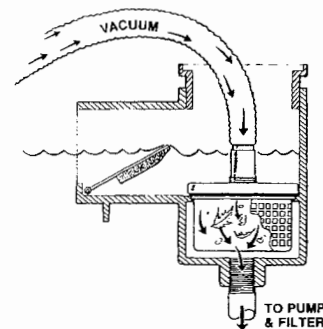

6. Keeping water in the hose, place the hose end over the skim-vac hose connection.
7. Insert the skim-vac into the skimmer and firmly place it over the basket. Hold it in place until all air is evacuated from the vac hose. Once the air is removed, the pump suction will hold the skim-vac in place.
8. Move the vacuum slowly back and forth to pick up debris. Do not remove the vac head from the water.
9. When you are finished vacuuming, turn the pump off, and disconnect and drain water from the hose. Clean out the skimmer basket, the hair and lint basket in the pump, and backwash or regenerate the filter.

Note: Always store your pool maintenance equipment, especially the vac hose, out of the sun.

Winterizing

In northern climates where winters are severe, it is extremely important that swimming pools are properly prepared for the freezing temperatures and ground frost. Freezing circulation lines and equipment are not only expensive to repair or replace, but the sudden loss of pool water caused by freeze breaks can do extensive damage to your pool structure and ruin the liner.

Note: Damage caused to the pool liner by ice or ice movement is not covered under your liner warranty.

Winterizing Instructions:

1. Clean the pool thoroughly.
2. Backwash or clean your filter completely, following the manufacturer's instructions.
3. Super-chlorinate the pool according to the instructions on the container.
4. Add a winterizing algaecide, available from your pool supply store; follow the instructions on the container.

Note: Always run the filter after adding chemicals, especially chlorine to disperse them evenly throughout the pool. See **Water Chemistry** in **Section II: Liner Care and Maintenance** for more information and precautions.

5. Remove all deck equipment such as ladders, step handrails, and diving boards. Cover mounting hardware with foam rubber or cardboard to prevent damage to your winter cover.
6. Drain the pool until the water level is 1" below the skimmer opening. Turn off the pump.
7. Drain the circulation lines. Most of the water will drain from your suction and return lines. However, it is recommended that they be purged using compressed air. See your pool professional.
8. Insert winterizing plugs (rubber or threaded cocolac, available at your pool supply store) into all suction and return lines. Place a "Gizzmo" or blocks of Styrofoam in the skimmer to absorb ice expansion.
9. It is not necessary to move the pump and filter indoors, but many home owners prefer doing this for absolute security. If you leave them outdoors, remove the drain plugs from the pump and filter tank and place them in the strainer basket inside the pump. Grease all plugs and openings with water pump grease. Multiport valves should be removed and put indoors.
10. Cover the pool immediately to prevent chemical loss and debris from entering the pool. On pools with walk-in stairs, be sure to use an air pillow under the cover in the stair area. This will extend the life of your cover.
11. Follow manufacturers' instructions for winterization of pool equipment such as heaters, automatic chlorinators, and underwater lights.

Keep water from collecting on solid covers until the pool freezes. Check your pool for water loss over the winter months. If you notice a drop in the water level, notify your pool professional immediately!

Visit your local pool retailer for the many other available winter cover options.

Summerizing

1. Leave cover on pool
2. Reach under cover, remove all plugs from returns and skimmer.
3. Reinstall all plugs on pump strainer housing and the bottom of filter tank using water pump grease on the threads.
4. Remove "Gizzmo" from the skimmer and reinstall skimmer basket.
5. Look under cover and check water level in pool. It should be down 4" from coping. If not, add water before operating filter.
6. At all times, have your pool water height at proper operation level (4" from top of wall.)
7. Prime filter pump and operate filter on the backwash cycle for three to four minutes. After cleaning filter, return multiport to filter operation and let operate. (Sand Filters Only.)
8. D.E. filters– Refer to manufacturer's instructions to pre-coat filter with diatomaceous earth prior to operation.
9. Using a leaf rake, clean leaves and debris from top of cover.
10. Hook vacuum cleaner up as if to vacuum your pool but leave the head hose and handle on top of the cover. Keep head of vacuum cleaner under water at all times.
11. Pools equipped with sand filters should be back washed. D.E. filters should be regenerated. Watch pressure on gauge. After an increase on 5-7 pounds, remove vac hose and clean skimmer basket.
12. Clean remaining leaves from the cover. **Drain water tubes on both sides and ONE end of cover only! Allow one water tube to remain full.** With two persons on the corners of the cover (opposite the end of the water tube that is full), grasp the corners and pull toward the other end until the cover is completely off the pool, being careful not to allow the cover to drop into the pool. Once the cover is completely off pool, drain remaining water tubes.
13. Spread the cover out on your lawn and hose it down thoroughly. Allow it to dry, flip it over and repeat the procedure on the opposite side. When the cover is clean and dry, sprinkle talcum powder over the entire cover, fold it, and store it in its original box in a cool dry place.
14. Before adding any chemicals to your pool, test the water for Sanitizer content and proper pH levels. If your pH level is not correct, any Sanitizer added will lose its efficiency. (See **Section IV: Sanitizing and Chemical Treatment.**)
15. Add Sanitizer according to manufacturer's instructions.
16. Cleaning of the water line can be done very efficiently with a vinyl cleaner manufactured specifically for vinyl liner pools.

Trouble Shooting Chart

PROBLEM	PROBABLE CAUSE	REMEDY
No pressure on gauges or violent fluctuating of gauges.	<ul style="list-style-type: none"> · Air in lines. 	<ul style="list-style-type: none"> · Water level in pool should be halfway up skimmer. · Hair and lint basket cover must be air tight. Tighten or replace as necessary. · Pump seal could be sucking air. · Possible loose clamp, cracked line or fitting. · Gauge defective.
Running at low pressures - low return flow	<ul style="list-style-type: none"> · Pump impeller or suction line plugged. 	<ul style="list-style-type: none"> · Turn off motor · Open hair and lint strainer, remove basket. · Insert wire hanger in hole leading to impeller, remove restriction with finger or wire. · If this does not work, remove motor and thoroughly clean impeller and housing, reassemble and use a new gasket, if needed. · Clean strainer basket and housing. (If gate valves are part of your filter system, make sure they are open.) · Clean suction line.
Running at high pressure - low return flow	<ul style="list-style-type: none"> · Dirty filter. · Return line restricted. 	<ul style="list-style-type: none"> · Backwash Sand Filter, Recharge D.E. Filter, Clean Cartridge Filter. · Stone could be lodged in return line. · Possible kink in return line. · Mark and remove manhole on filter tank, remove leaves and dirt on top, loosen sand bed to about six inches and discard all mud balls or dirt, re-level bed, and backwash.
Dirt returns to pool while vacuuming.	<ul style="list-style-type: none"> · Muddy water solution too fine for filter to clean in large quantities while vacuuming. 	<ul style="list-style-type: none"> · Backwash more often. · Proceed as in problem-Running at high pressure. · If above fails, vacuum to waste.
Dirt returning to pool after backwashing.	<ul style="list-style-type: none"> · Filter media is clogged with oils, mudballs, hair, etc. and/or underdrain in filter defective. 	<ul style="list-style-type: none"> · Proceed as in problem-Running at high pressure. · Clean filter following manufacturer's instructions. · Replace underdrain or replace filter.
Milky water returning to the pool.	<ul style="list-style-type: none"> · Undissolved chlorine on surface of filter bed. 	<ul style="list-style-type: none"> · Dissolve chlorine and water in a bucket, and then pour solution into pool. (Residue in bottom of bucket should be thrown away.) Avoid placing chlorine in skimmer. · Proceed as in problem-Dirt returning to pool after backwashing. · Suggestion: Try to avoid oily or greasy hair creams and suntan lotions in the pool.
No vacuum, although filter works properly.	<ul style="list-style-type: none"> · Obstruction in vacuum hose or head. 	<ul style="list-style-type: none"> · Check vacuum head and hose for stones and leaves.
Leaves in pool and vacuum stops while you vacuum.	<ul style="list-style-type: none"> · Lines plugged with leaves. 	<ul style="list-style-type: none"> · Clean hair and lint basket, start filter and let run without vacuuming, recheck hair and lint basket and clean. · If line remains plugged, clean suction line. All excessive amounts of leaves in pool should be removed with a leaf rake made for that purpose.
Short filter cycles.	<ul style="list-style-type: none"> · Filter bed plugged. · Not enough backwash time to clean filter. 	<ul style="list-style-type: none"> · Backwash and refer to problem - Dirt returning to pool after backwashing.
Noisy Motor.	<ul style="list-style-type: none"> · Air in suction lines. · Bad bearings. 	<ul style="list-style-type: none"> · Check suction line for air leaks, fittings, pipes, cover on hair and lint basket and clamps. · Remove motor and have bearings checked.
Pump leaking water.	<ul style="list-style-type: none"> · Motor pump gasket. · Pump seal (when water leaks from motor shaft). 	<ul style="list-style-type: none"> · Replace gasket or seal.
Motor will not start.	<ul style="list-style-type: none"> · Stone lodged in impeller. · Shaft frozen. · Bad starter switch. · Improper voltage. · Blown fuse. 	<ul style="list-style-type: none"> · Turn motor off and try to turn impeller by hand and remove stone. · Turn motor off and turn impeller by hand. · Have adjusted or replaced. · Call electrician. · Replace proper fuse.
Pool losing water.	<ul style="list-style-type: none"> · Multiport by-passing water to waste. · Leak in piping or fitting. · Hole in liner. 	<ul style="list-style-type: none"> · Install new multiport valve gasket. · Shut pump off. If pool continues to lose water at same rate, leak is most likely to be in liner. If pool stops losing water or slows the rate of loss when pump is off, leak may be in return line. If suction line is leaking, water loss may not be detectable, however, air bubbles will be present in return flow. · To locate puncture, vacuum pool clean and then, with filter closed, proceed to examine the pool walls, corners, bottom and seams. Holes often look like small black marks on the liner.
Vacuum head sticking to pool bottom when vacuuming.	<ul style="list-style-type: none"> · Too much suction from pump. 	<ul style="list-style-type: none"> · Turn flo-selector handle from the off position towards the on position until vacuum head releases.

SECTION V: Installation

***IMPORTANT NOTE:

MAKE SURE you verify liner dimensions on box label to specifications of the pool **BEFORE** liner is removed from carton. If you have any questions call us before removal and installation.

To insure the proper fit of a new liner, it is very important that finished dimensions of the pool and pool bottom match all dimensions for which the liner was fabricated. This is the single most important factor in obtaining a smooth, wrinkle-free fit.

DO NOT OVERSTRETCH THE LINER, SINCE DOING SO WILL SHORTEN ITS SERVICE LIFE AND VOID THE WARRANTY!

Preparation of the Pool Bottom

The liner placement may only require the installation of a new liner on an existing hard bottom or re-troweling a sand bottom. However you may find it necessary to start from scratch.

Material Selection for Finished Pool Base

In forming your required finished pool base, select the pool base material conducive to the soil conditions and the capabilities of your finishing crew.

CONCRETE: A pool base consisting of a 4000 pound mix (small stone, Portland cement and water) will provide a permanent bottom for the pool. There are, however, some factors that should be considered prior to selecting a concrete bottom. First, it is imperative that you have experienced masons available to do the troweling. This type of mix sets up rather quickly and must be done correctly the first time. It is necessary to have a finish smooth enough so as not to harm the liner. Once bottom has been finished, we recommend that the entire area be checked for smoothness. Any sharp areas must be eliminated and then the whole pool bottom should be washed thoroughly before installing liner. Main drains with a hydrostatic relief valve should be installed as part of this bottom.

VERMICULITE: Another type of hard bottom material is referred to as Concrete pool base aggregate. This material provides a nonabrasive surface for the liner while providing a hard surface resisting the formation of pockets or foot prints. Mixed with water and Portland in a paddle type mixer it should be applied according to manufacturer's instructions.

NOTE: When you trowel vermiculite, do not try to attain a smooth surface. A too smooth surface will allow the liner to slide on the pool bottom causing wrinkles.

MASON SAND AND PORTLAND CEMENT: A mixture of sand and cement provides a hard surface for the pool bottom eliminating the depressions found in bottoms with mason sand only. It is an acceptable base for the liner in unstable ground conditions (clay or high water table). Follow manufacturer's instructions for mixing and application. This mixture can also be ordered from a ready mix company in order to eliminate hand mixing. Periodic spraying of water should be applied to the pool base during and after troweling to keep moist until the liner is installed.

NOTE: Sand must be clean (washed) and free of bacteria and organic materials. This will prevent staining of the liner. Staining caused by contaminated base material is not covered under the liners limited warranty.

MASON SAND: This type of sand is fine enough to provide a firm base for the liner. It must be tamped thoroughly, before troweling, to insure firmness. By spray misting water from a hose nozzle, it will compact and make it easier to trowel. Spray misting should be done periodically to keep moist, until liner is installed. Disadvantages of sand as a pool base is that it may show depressions and indentations from usage. It is not recommended in areas with high water tables.

Troweling the Pool Base

Use mason line to outline the shape of the pool bottom per dimensions required. Start in the hopper end and place the pool base on the slopes, troweling the side slopes and deep end first. After these slopes are finished, trowel the shallow end of the pool. Next, work down the long slope to the bottom of the hopper. Finish troweling the hopper bottom and exit the pool by ladder or rope.

NOTE: If pool has a one-piece thermoplastic or acrylic step, review installation note and drawings under (Installation of a Liner with One-Piece Steps), before troweling pool base.

Preparation of Pool Structure

1. Clean the pool structure. The walls must be smooth and free of dirt and grime that could show through or puncture liner.
2. Replace all damaged or questionable wall fittings and skimmers. Follow the manufacturer's instructions.
3. In order to secure the air tight fit that is needed when liner is being set with the use of an industrial vac (**See Liner Installation**), all interior seams where walls are jointed together, including steel stairs should be taped using high quality duct tape. All exposed bolt heads should also be taped.
4. After taping the pool interior seams, optional foam padding may be applied to the walls, vinyl covered stairs, cuddle coves and benches. This covers any roughness and also provides a cushion for the liner. The foam is adhered to the pool walls with the use of spray adhesive.
NOTE: Use only foam padding and adhesive designed for this type of application. These are available from your pool supply professional.
5. Apply the adhesive by spraying top, bottom and sides of each panel first, and then spray an X in the center. Smooth on the wall foam immediately.
6. Place duct tape on all wall foam seams.

Liner Installation

Liner should only be installed when temperatures are 60°F or above.

Before installing the liner, make sure that the pool walls, pool bottom, coping and general working area is clean and free of sharp materials that could snag or puncture the liner. Tape over any sharp edges on the pool coping.

Four people will be required for installation of the pool liner.

Note: If you are installing a liner into a pool with one piece thermo-plastic or acrylic steps review (*Installation of Liner with One-Piece Steps*) before starting.

1. Locate industrial vacuum at the skimmer. Insert the suction hose into the skimmer from the cover, out the front, and down the pool wall to within 5" of the bottom. Tape skimmer cover opening to secure an airtight fit.
2. Place the liner at the deep end of the pool. Unfold as illustrated on box.
3. While two people hold the liner on the edge of the pool at deep end, two persons should begin to walk liner to the shallow end.
4. Position the liner squarely in the pool. * See drawings below.

Note: If you are installing a liner into a pool with a Vinyl Covered Stair, bench, Cuddle Cove or Sun Deck. Go to (*Installation of Liner with Vinyl Covered Stairs*) before starting step 5.

5. Secure the liner in the shallow end first. Place the liner bead into receptor extrusion along the shallow end wall, making sure the corners are in position.
6. Continue placing the liner bead into the extrusion working along each side toward the deep end until the deep end corners are in place.
7. Be sure that the bottom corners in the shallow end of the pool are

flush against the wall. Water tubes placed along the shallow end wall will help hold liner in position.

8. Shift liner around the pool perimeter as required to position the corners correctly.

If you need to enter the pool when positioning liner into place, NEVER wear work boots or any other footwear while on the liner. Wear clean socks only to avoid any scuffing of liner print and damaging liner. This type of damage is not covered under the limited warranty.

Final Positioning of the Liner

1. Turn the vacuum on and pull out any wrinkles and adjust liner to match pool bottom. Wrinkles can be removed by reaching over the wall and pulling on the sidewall material. If necessary, turn vacuum off to reposition the liner. Then turn it on again when finished.

2. Once liner is positioned properly and wrinkles have been removed, start filling the pool with water.

If the pool has one or more main drains install the face ring, gasket and cover on each drain after there is approximately 12" of water in the deep end. Follow the manufacturer's instructions for installation.

Make sure main drain and replacement grates or covers used comply with the ANSI/ASME A112.19.8 2007 standards and the Virginia Graeme Baker Pool & Spa Safety Act.

NOTE: Leave the vacuum in place and running until the water reaches a depth of at least 4" in the shallow end. If the vacuum is removed before the water reaches this point, the liner may slide toward the deep end, creating unsightly wrinkles and possibly causing damage to the liner. If the vacuum is shut off too soon, drain the pool immediately and reposition the liner.

TO INSURE PROPER LINER FIT AND TO AID YOU IN INSTALLATION PROCEDURES, THE VINYL WORKS HAS PLACED RED VINYL ARROWS ON THE UNDERSIDE OF THIS LINER AT KEY POINTS.

PLEASE REVIEW THE DRAWINGS BELOW TO SEE WHERE THE ARROWS HAVE BEEN PLACED ON THE LINER YOU ARE INSTALLING.

RECTANGLES AND GRECIANS WILL BE MARKED AT BOTH ENDS AT THE INSIDE OF EACH CORNER AS SHOWN.

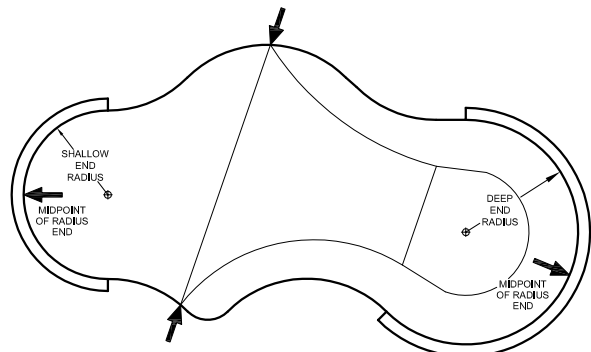
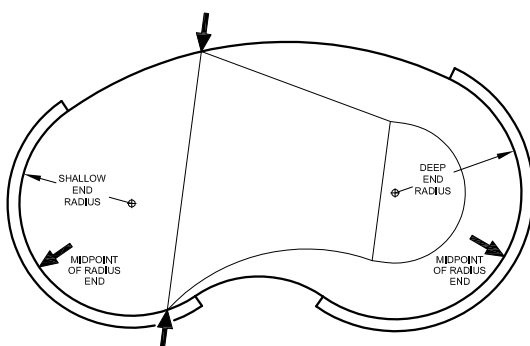
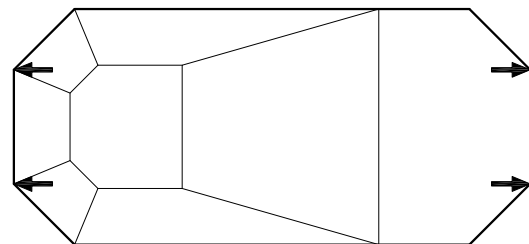
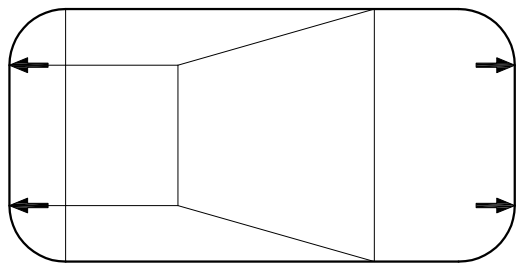

FREEFORMS, MOUNTAIN LAKES, KIDNEYS, ETC. WILL BE MARKED AT EACH SIDE OF THE BREAKOVER AS WELL AS THE MIDPOINTS OF THE DEEP END AND SHALLOW END RADIUS' AS SHOWN.

- When the water level reaches 4" in the shallow end, turn the vacuum off remove it from the skimmer opening and adjust the liner if necessary. **If you are installing a liner into a pool with a one piece thermoplastic or acrylic steps go to # 5 under (Installation of Liner with One-Piece Steps).**
- Continue filling pool to normal operating water depth.

Installation of Faceplates, Skimmers, Return Fittings, Lights and Safety Rope

NOTE: Do not install the faceplates for the skimmers, return fittings lights or safety rope until the water level is well over these items. If they are installed and cut to soon, the liner may shift as it fills, causing it to tear at these locations.

- Position the faceplate over the fitting so the holes line up.
- With a pointed tool, penetrate the liner where each hole is and affix the faceplate with the self tapping screws provided with the fitting.
- Cut the opening with a razor knife. Make sure when cutting opening you are cutting around the inside of the faceplate.

Installation of Liner with Vinyl Covered Stairs

Follow the same procedures as previously outlined (See *Liner Installation, Steps 1-4*).

Depending on how your liner was ordered and fabricated you will be using one of the following installation guidelines.

Installation with Stair Rods because Liner has been fabricated using Rod Loops.

- Before starting first tape ends of each stair rod (Not included with liner) with duct tape to prevent snagging during installation. Rods may need to be cut to correct length to fit the inside of each tread.

Make sure the stairs are clean before starting.

Upon reaching the shallow end with liner, insert the stair rods into the rod loops on the back of stair section. Use caution when inserting rods through rod loops to avoid damaging liner.

- Starting at the bottom step and working up, position the liner and secure each rod into place.

Rods can be secured into place several different ways:

Galvanized Stair Rod Clips (Steel Stairs only) are inserted into joint between tread and riser on the steel stair. You may need to tap the end of flat head screwdriver into joint providing a lead hole for each clip. Don't make the lead hole too large preventing the clip from having the tight fit needed in securing rod. Use a rubber mallet to pound clips into lead holes.

Nylon Stair Rod Clips are secured to the stairs using Tek screws. Clips slide over rods for installation; number of clips needed is to be determined by installer. **(Cover all clips with duct tape to protect liner once they are secured in place.)**

Treaded Rods can be used on new installations (Straight Stairs Only) before pool is backfilled.

Installation with Liner Bead because Bead Receiver has been installed on Stair Treads.

(Liner must be ordered and fabricated with Liner Bead for stair treads)

Make sure the stairs are clean before starting.

Upon reaching the shallow end with the liner, start at the bottom step and work you way up. Position the liner and insert liner bead into the bead receiver installed on each stair tread. Depending on what type of bead receiver was installed after liner is positioned, Liner Bead Wedge Lock may be needed to secure into place. (Not included with liner.)

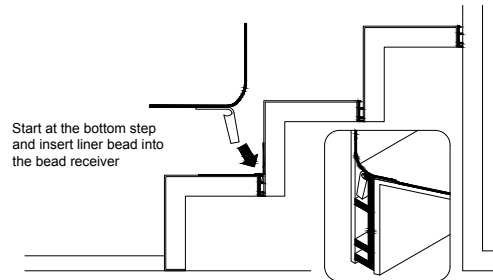

Important Note: If it becomes necessary to remove the liner bead from the bead receiver so the liner can be reset, **follow these guidelines to prevent damaging the liner.**

PUSH THE LINER MATERIAL FORWARD on the tread using a Vinyl Works Liner Stair Bead Assistance Tool (Item - **VWSBAT1** for Straight Stairs and **VWSBAT2** for Radius Stairs). This will relieve the tension on the liner bead allowing the liner material to pull **STRAIGHT UP** and **OUT** from the bead receiver. **NEVER try to just pull the liner bead from the bead receiver without relieving the tension first.** Over pulling could damage the liner. (See guidelines on the drawing below.)

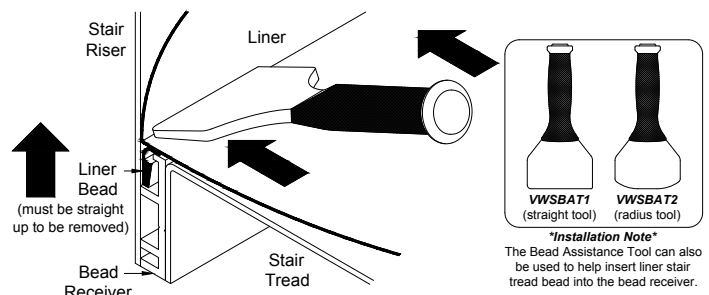

If Bead Removal Assistance Tool is not available, you can use your hands to push the liner material forward to relieve the tension. **NEVER use tools that could damage the liner, such as screwdrivers, scrapers or putty knives.** (See drawing for details.)

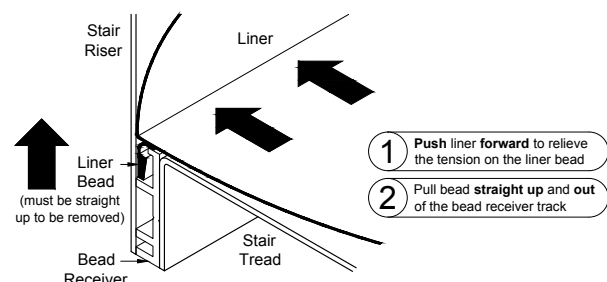

****Liner Installation and Removal shown for Steel walls. Procedure is identical for Polymer walls****

Installation of Liner with One-Piece Steps

1. Remove the stair unit faceplates and check gaskets to insure they are positioned properly. (Separate gasket models only)
2. Before installing the pool liner make a jig using the following materials.
 - (1) 4'x 8' 5/8" sheet of plywood
 - (1) 2" x 4" x 8' board
 - (1) 8' vertical liner extrusion
 Assemble the jig as shown:

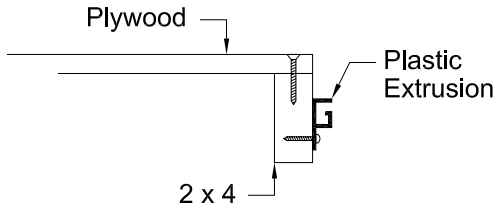

3. Lay the jig on top of the stair unit and tape around edge with duct tape for a good seal with the vacuum.

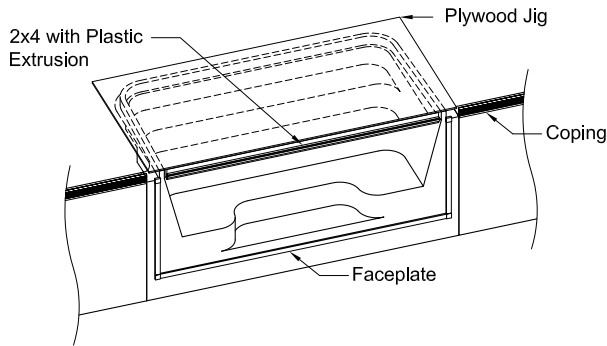

4. Follow installation procedures as outlined. **See Liner Installation**
These are general universal guidelines. If you have the step manufacturers installation instructions use those first.
5. Starting with the bottom horizontal faceplate and gasket (if required) with the liner in place, line up the pre-drilled screw holes.
 Start with the center screw and work from the center out. Once all screws are in place, tighten them evenly.

NOTE: DO NOT OVERTIGHTEN THE FACEPLATE SCREWS!
OVERTIGHTENING WILL STRIP THE DEAD END BACKER BLOCK, CAUSING THE POOL TO LEAK.

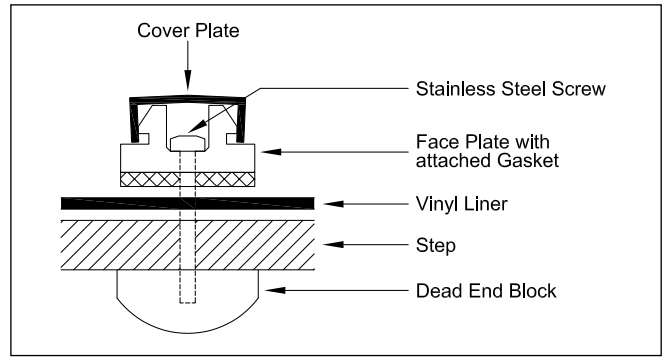

Co-Extruded Attached Gasket

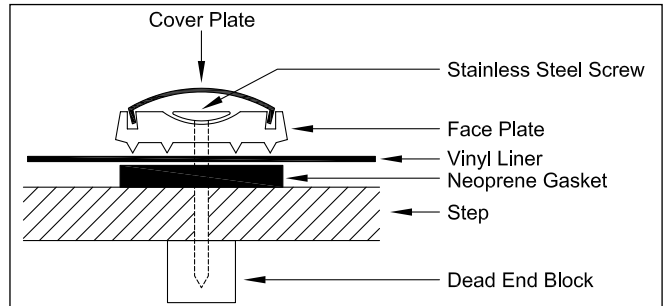

Separate Gasket

6. Next, install faceplates on the sides of step unit in the same manner as the bottom.
7. Snap the faceplate cover strips and end caps in place.
8. **Slice the liner in the middle of the step to relax liner material. Cut the liner out around the inside of the step faceplate. Remove the liner from the step section.**

IMPORTANT NOTIFICATION:

IT IS THE RESPONSIBILITY OF THE INSTALLER TO INSTALL OR REINSTALL ANCHOR DEVICES AND THE ROPE AND FLOAT ASSEMBLY FOLLOWING THE INSTALLATION OF THE LINER.

** IMPORTANT NOTICE TO INSTALLER:

After installation is complete read over the Safety Section in this manual to see your responsibilities as the installer of this swimming pool liner.

CORRECT

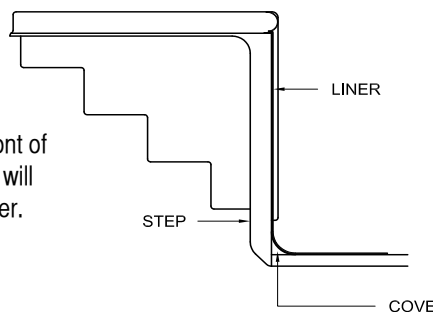

INCORRECT

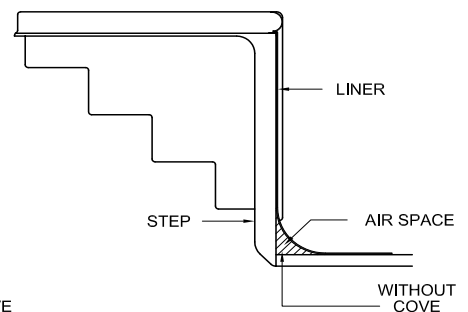

Installation Note: When finishing pool base in front of step unit, taper it up and make a slight cove. This will help to relieve any excessive pressure on pool liner.

Appendix G

Safety Considerations and Warning Recommendations

This appendix is not part of the American National Standard ANSI/PHTA/ICC-5 2011. It is included for information only.

The Pool and Hot Tub Alliance (PHTA) suggests that the builders/installers of swimming pools advise the initial owner/operator of a residential pool of the following:

Warning Recommendations: The PHTA suggests the builder/installer advise the pool owner of the risk of drowning, especially for children under the age of five, and the risk of diving into shallow water in one or more of the following ways: verbally, through publications or signage. The following are suggested recommendations:

Lifesaving Equipment: The PHTA suggests the builder/installer advise the pool owner/operator that basic lifesaving equipment including one or more of the following items should be on hand at all times:

- A light, strong, rigid pole not less than twelve feet (12', 3.7 m) long
- A minimum one fourth inch (6 mm) diameter throwing rope as long as one and one-half (1½) times the maximum width of the pool or 50 feet (15.2 m), whichever is less, which has been firmly attached to a Coast Guard-approved ring buoy having an outside diameter of approximately 15 in. (381 mm), or some other similar flotation device.

Safety Considerations for Pool Owner/Operators:

For additional safety information see www.PHTA.org

This standard does not replace good judgment and personal responsibility. In permitting use of the pool by others, owners/operators must consider the skill, attitude, training, and experience of the expected user. It is the pool owner/operator's responsibility to learn, understand, and enforce these basic safety principles and rules:

- Encourage children to learn how to swim.
- Never allow diving, jumping or sliding into shallow water.
- Adequate adult supervision is required when the pool is in use.
- Adequate adult supervision is always required when children are present.
- Encourage parents to learn CPR.
- Encourage children to never swim alone.
- Keep all electrical radios, speakers and other appliances away from the swimming pool.
- Do not allow roughhousing and horseplay.
- Keep deck clean and clear of objects that may create a hazard.
- Keep all breakable objects out of the pool area.
- Alcohol consumption and pool activities do not mix. Never allow anyone to swim, dive or slide under the influence of alcohol or drugs.

Do's and Don'ts for Diving into swimming pools with manufactured diving equipment, diving rocks, and stationary diving platforms:

- Do know the shape of the pool bottom and the water depth before you dive or slide headfirst.
- Do plan your path to avoid submerged obstacles, surface objects, or other swimmers.
- Do hold your head up, arms up, and steer up with your hands.
- Do practice carefully before you dive or slide.
- Do test the diving board for its spring before using.
- Do remember that when you dive down, you must steer up.
- Do dive straight ahead, not off the side of the diving board.
- Don't drink and dive.
- Don't dive or slide headfirst in the shallow part of the pool.
- Don't dive from any place that is not specifically designed for diving.
- Don't ever dive head first into shallow water (5 feet or less).
- Don't dive across the narrow part of the pool.
- Don't run and dive.
- Don't dive from any place that is not specifically designed for diving.
- Don't engage in horseplay on diving or sliding equipment.
- Don't use diving equipment as a trampoline.
- Don't do a back dive.
- Don't try fancy dives; keep the dives simple.
- Don't dive or slide headfirst at or through objects such as inner tubes.
- Don't put diving or sliding equipment on a pool that wasn't designed for it.
- Don't swim or dive alone.
- Don't dive into unfamiliar bodies of water.

Rules for General Use of Swimming Pool Slides.*

Under all circumstances you should prohibit:

- All headfirst entry from slide.
 - Horseplay.
 - Any slide entries by non-swimmers into deep water, to protect them from drowning.
 - Standing on the top of a slide or outside the guardrails.
 - Jumping from a slide.
 - Diving from a slide.
 - Sliding into areas with submerged obstacles, surface objects, or other swimmers.
 - Do not engage in extended breath holding activities underwater.
- * Consult safe use instructions of the pool slide manufacturer.

Appendix F

Recommendations to Warn Against Shallow Water Diving

This appendix is not part of the American National Standard ANSI/PHTA/ICC-5 2011. It is included for information only.

Recommended methods to warn against shallow water diving may include, but not be limited to:

A. Safety Signs

It is an open question before the Human Factors Society and others whether signage is an effective means that will modify human behavior to prevent accidents.

If warning signs are used to warn against shallow water diving, the signage should be in compliance with ANSI-Z535 series of standards for safety signs and colors or the latest revision.

This sign is based upon a study entitled "Design of Swimming Pool Warnings." This sign has been reviewed by the staff of the U.S. Consumer Product Safety Commission and supports its use.

B. Additional Signage Use

The ANSI-Z535 Series of Standards reflects the consensus of various experts on warning sign appearance and content. Signage, which is consistent with the ANSI-Z535 Standards,

Figure 8 Sign warning against shallow water diving



is permitted to be added to components, equipment, facilities, or installations, to provide additional information.

Manufacturers are permitted to either affix additional signage to their products or packaging, or to supply the signage with the product to be affixed at the time of installation.

Appendix H

Safety Brochures and Education Programs

This appendix is not part of the American National Standard ANSI/PHTA/ICC-5 2011. It is included for information only.

Consumer awareness information is available from the following sources:

- "The Sensible Way to Enjoy Your Inground Swimming Pool" Published by the Pool and Hot Tub Alliance (PHTA)
- "Children Aren't Waterproof" Published by the PHTA
- "Be Safety Aware" Published by the PHTA
- "Layers of Protection" Published by the PHTA
- "Pool and Spa Emergency Procedures for Infants and Children" Published by the PHTA
- "Knowing How to Dive" Published by the PHTA

Copies of the above brochures are available free from the PHTA at 703-838-0083, ext. 301.

Also, visit PHTA's website at www.PHTA.org and consult "Consumer Information."

Safety Education Programs and Materials

Educational programs and materials (i.e., seminars, workshops, brochures, videos, instructional guides, etc.) are available from PHTA, NSPF, other aquatic safety groups, and by private firms. As a means of communicating useful safety information to pool owners/operators and users, industry members are permitted to provide such information to owners/operators and to request or require owners/operators to sign a statement that they have received, read and will follow the guidelines.

PHTA
2111 Eisenhower Avenue
Alexandria, VA 22314
703-838-0083
www.PHTA.org

Appendix K Entrapment Avoidance

This appendix is not part of the American National Standard ANSI/PHTA/ICC-5 2011. It is included for information only.

WARNING

Drowning Hazard



Avoid Drain Covers



Avoid Body Entrapment



Avoid Evisceration



Avoid Hair Entanglement



Avoid Finger Entrapment

- **Never play or swim near drains or suction fittings. Your body or hair may be trapped causing permanent injury or drowning.**
- **Never enter the pool or spa if a suction fitting or drain cover is loose, broken, or missing.**
- **Immediately notify the pool/spa owner or operator if you find a drain cover loose, broken or missing.**

For further information, contact The Pool and Hot Tub Alliance (PHTA).

Visit the U.S. Consumer Product Safety Commission website to read their entrapment guidelines at:
www.cpsc.gov/cpscpub/pubs/363.pdf

IMPORTANT SAFETY NOTE: If you choose to display this warning device as a sign, please make sure that it conforms to ANSI/NEMA Z535.4 Standard for Product Safety Signs and Labels, 2002 or latest revision.



The Vinyl Works Inc.
Corporate Services/Warranty Dept.
33 Wade Rd., Latham, NY 12110



Limited Warranty

Vinyl Works Inground Residential Swimming Pool Liners

Date Warranty Begins

- The warranty begins on the date of installation.
- This product is warranted by Vinyl Works, Inc. to the original purchaser only against failure resulting from workmanship in welding seams and edges for Twenty (20) years, with the replacement cost to be prorated after the third (3rd) year.

What is Covered

- This warranty applies only to liners purchased for private residential use.
- The pro rata replacement schedule are the following percentages of the fabricator's current suggested list price. The percentages are based on the length of time you have owned your liner measured from the date of installation:

Within 3 years.....No Charge	After 5 years.....50%	After 7 years.....70%
After 3 years30%	After 6 years.....60%	8-20 years80%
After 4 years40%		

What is Not Covered

- This warranty does not cover damage caused by shipping, mishandling, faulty installation, improper acts of others, or acts of God.
- This warranty specifically excludes holes, cuts, tears along seams, bleaching, and wrinkles, which develop over time. These conditions are caused by misuse, improper installation, improper addition of chemicals, or poor maintenance of pool water chemical balance. Your liner must be installed according to the directions and properly maintained.
- This warranty does not cover chemical related damage sustained in pools with automatic pool covers.
- This warranty does not cover damage including fading resulting from improper use of (Salt) Chlorine Generators.
- This warranty does not cover the abrasion of pool liner print caused by automatic pool cleaners.
- This warranty does not cover ice damage.
- This warranty does not cover any failures due to material defects. Material used to fabricate this pool liner was not produced by Vinyl Works, Inc. Failures are to be referred to the manufacturer of such material.
- This warranty does not cover normal fading of color, or microbiological staining. All colored vinyl products, subjected to direct rays of the sun, may fade in time. Such fading, or microbiological staining, does not qualify as a material defect. Staining or fading does not affect the ability of the vinyl to perform its intended function.
- This warranty does not cover irregularities, imperfections, or damage, which may result from the removal of water from the liner. You should keep the pool full of water at all times.
- This warranty is null and void if alterations are made to the pool design or if accessories that can cause damage to the liner are used.

What We Will Do For You

- We will replace or repair, according to the pro rata schedule, any liner found to be defective. Charges for shipping, removal, installation, water, and service calls are not covered by this warranty.
- Replacement will be completed within 10 business days of confirmation of the defect and receipt of your payment, if required.

How To Obtain Warranty Service

- If your liner should fail within the first three years, please contact the dealer you purchased the liner from originally. If your liner should fail after year three please send a letter or e-mail to our factory identifying the liner and date of installation, along with proof of purchase and photograph of failure to: Imperial Pools Inc, 33 Wade Road Latham, NY 12110 Email - info@imperialpools.com
- Determination of the claimed defect may be made upon receipt of the liner at our factory. At our option, confirmation may be made by an authorized representative at the pool site.
- All warranty claims must be made directly with Vinyl Works, Inc., and no merchandise is to be returned to us without prior written authorization.

Disclaimer of Consequential Damages

- Under no circumstances will The Vinyl Works, Inc. become liable for Special, Incidental or Consequential Damages. This includes but is not limited to Any Damages for Loss of use of Pool, Injury To, Or Death Of, Any Person/Persons, Or Damage to Property. Any Claims Therefore are Hereby Specifically Disclaimed and Excluded. Some states do not allow the exclusion of special, incidental or consequential damages, so this above limitation may not apply to you.

Limitations of Warranties

- This warranty shall be unenforceable if you are in default under the terms of any agreement executed in connection with the purchase or installation of this liner.
- This warranty is intended to be in lieu of any and all warranties expressed or implied. It is a complete statement of our obligation.
- No agent or dealer or other individual is authorized to change this warranty and any such change will not be recognized by Vinyl Works, Inc.
- This warranty gives you specific legal rights. You also have implied warranty rights, and may have other rights which vary from state to state. In the event of a problem with warranty service or performance, you may be able to go to small claims court, state court, or federal court.
- This warranty is in compliance with the Consumer Product Warranty and Federal Trade Commission Improvement Act.

Serial Lot No. _____



THE VINYL WORKS INGROUND RESIDENTIAL SWIMMING POOL LINER WARRANTY REGISTRATION

Please complete this form, detach and mail with proper postage within 30 days of installation. You can also access the form by visiting www.mypoollinerregistration.com or by scanning the QR code below with your phone's camera.

I HAVE RECEIVED AND REVIEWED THE SAFETY INFORMATION PROVIDED:

- *Pool Owners Manual*
- *"The Sensible Way To Enjoy Your Inground Swimming Pool" Booklet*
- *"Layers of Protection" Booklet*
- *"Children Aren't Waterproof" Pamphlet*
- *"Pool And Spa Emergency Procedures for Infants and Children" Booklet*
- *"No Diving" Labels*
- *"Safety" Sign*
- *"Plan Your Dive, Steer Up" Pamphlet **
- *"Warning" Label **



Owner's Name _____

Date of Installation _____

Address _____

Purchased From _____

City _____

State _____ Zip Code _____

Owner's Signature _____

Installed By _____

* Warning labels only given with pools approved for use with manufactured diving equipment, per ANSI/PHTA/ICC-5 2011 Standard for Residential Inground Swimming Pools

Serial Lot No. _____



33 Wade Rd., Latham NY 12110



Formerly The Association of Pool & Spa Professionals/National Swimming Pool Foundation

Imperial Pools Manufacturing and The Vinyl Works are longtime members of The Pool & Hot Tub Alliance. The Registered Trademark of The Pool & Hot Tub Alliance has been used by permission for this publication.

10/23 #25403

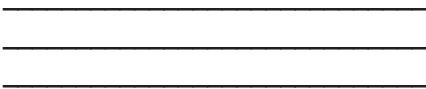

**Affix
Postage
Here**

The Vinyl Works, Inc.
Corporate Services / Warranty Dept.
33 Wade Road
Latham, NY 12110